

Front View

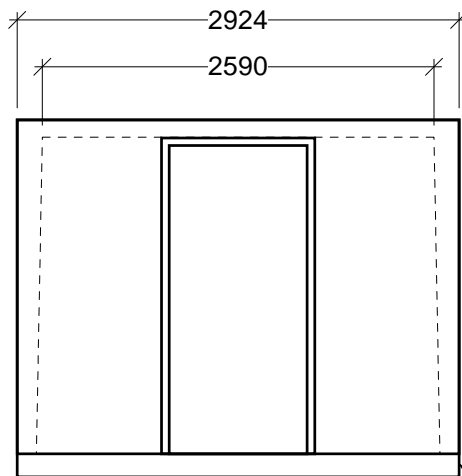

End View

- Roof Coverings and Eaves Trough Available.
- Standard Simulated Wood Finish or a Variety of Other Exterior Finishes Available.
- Clear Acrylic Sealer - Exterior.
- Multiple K/O (Window and Door) Locations Available. (TBC)
- Optional Interior Finishes Available.
- Custom Heights Available.

General Notes:

- Product manufactured in accordance with CSA A23.4
- Lift Points Provided (See Shop Drawing for Quantity & Locations)
- Site Installation & Suitability for Use is the responsibility of others

3262QS Vault Building

Scale 1:50 mm

Chamber: 34,700 lbs / 15,740 kgs



A.E. CONCRETE
 Con-Force Division of Armtec Limited Partnership
Office: 19060 - 54th Ave. Surrey, BC V3S 8E5
 Tel (604) 576-1808 Fax (604) 576-2454
Shipping: 5353 - 192nd St. Surrey, BC V3S 8E5
 Website: www.ae-concrete.com

Rev: 22Dec08

Dwg#: 3262QS-20-ZZZZ-C

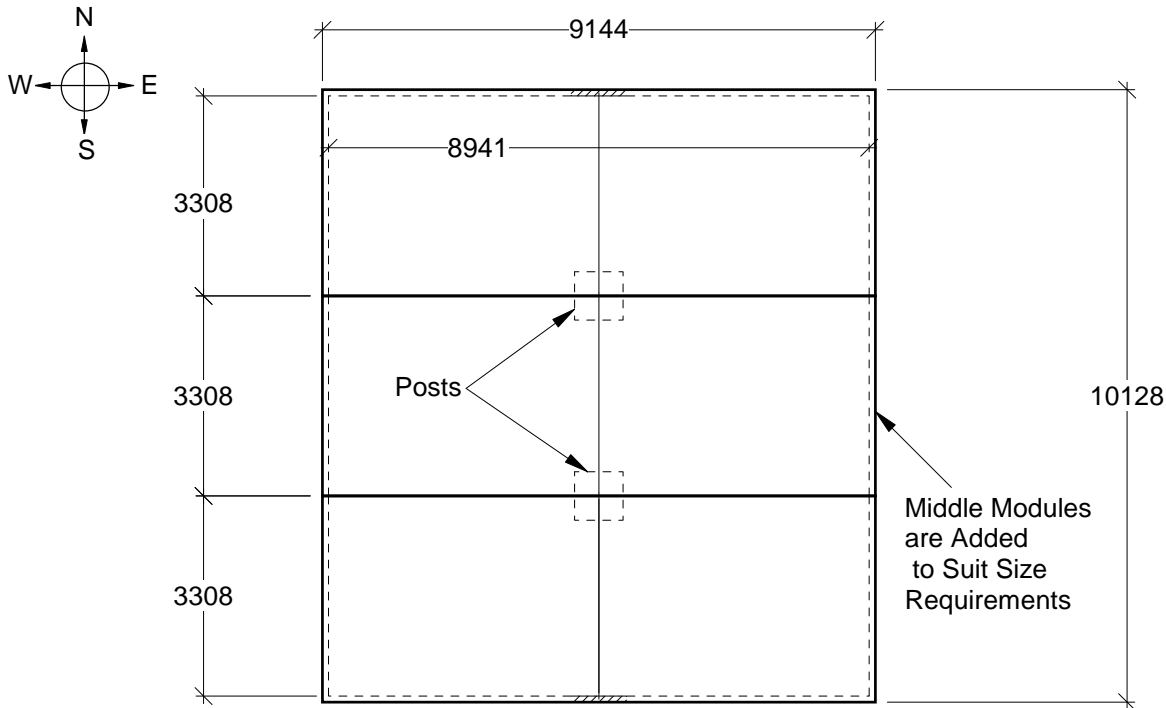

Plan View

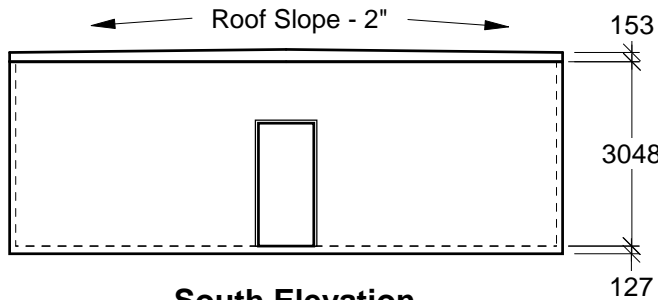

South Elevation

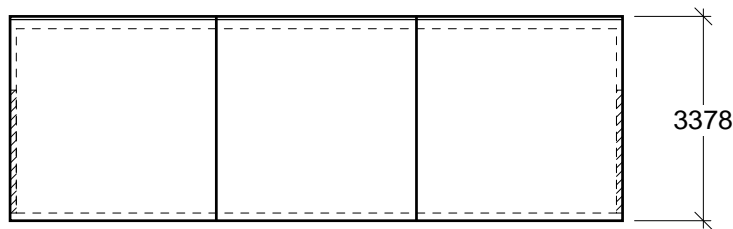

East Elevation

- Roof Coverings and Eaves Trough Available.
- Standard Simulated Wood Finish or a Variety of Other Exterior Finishes Available.
- Clear Acrylic Sealer - Exterior.
- Multiple K/O (Window and Door) Locations Available. (TBC)
- Optional Interior Finishes Available.
- Custom Heights Available.

General Notes:

- Product manufactured in accordance with CSA A23.4
- Lift Points Provided (See Shop Drawing for Quantity & Locations)
- Site Installation & Suitability for Use is the responsibility of others

903330 Precast Modular Shelter / Building

Scale 1:125

End Module Wgt: ~70,000 lbs / 31,800 kgs

Middle Module Wgt: ~55,000 lbs / 25,000 kgs

Rev: 22Dec08

Dwg#: 9333-20-ZZZZ-C



A.E. CONCRETE
 Con-Force Division of Armtec Limited Partnership
Office: 19060 - 54th Ave. Surrey, BC V3S 8E5
 Tel (604) 576-1808 Fax (604) 576-2454
Shipping: 5353 - 192nd St. Surrey, BC V3S 8E5
 Website: www.ae-concrete.com

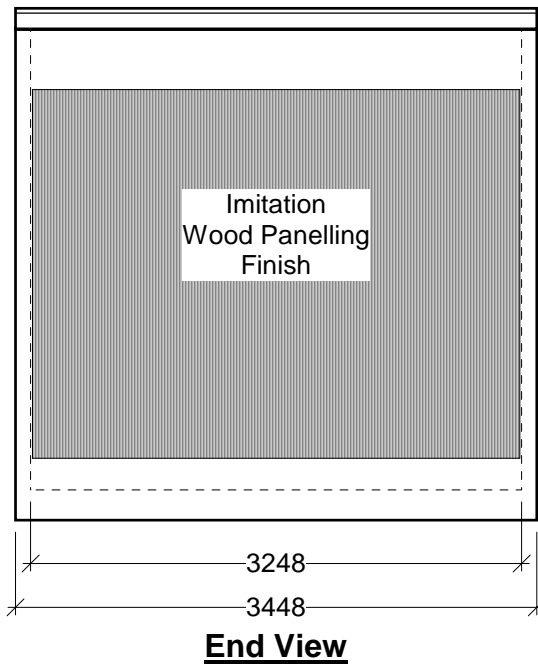
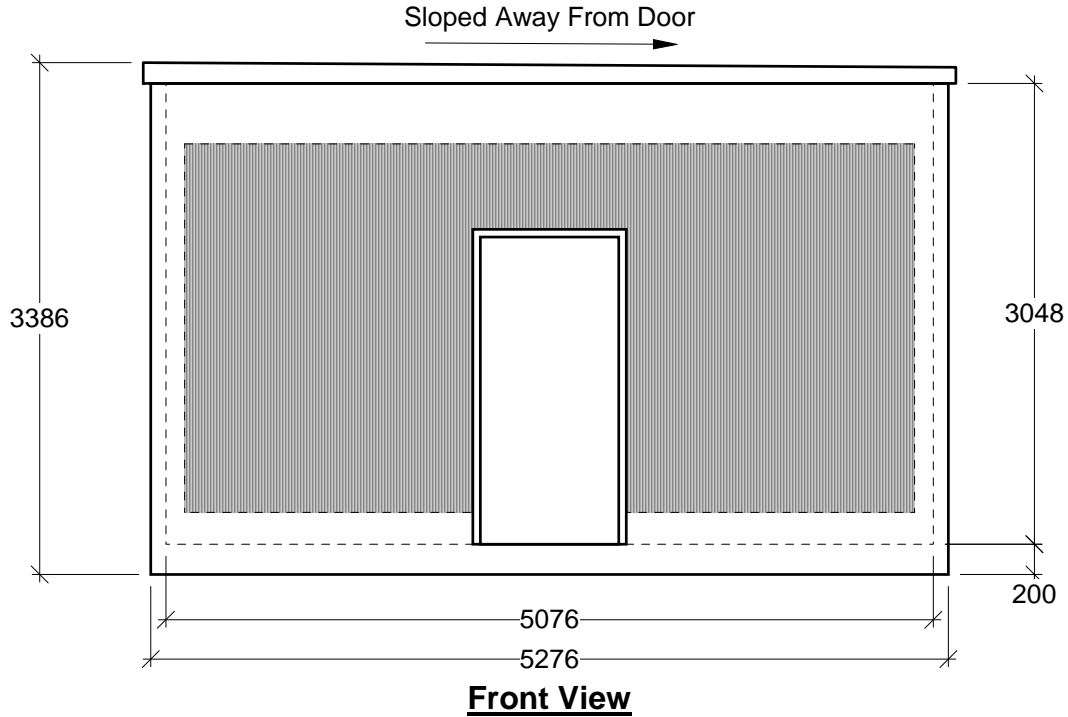

- Roof Coverings and Eaves Trough Available.
- Standard Simulated Wood Finish or a Variety of Other Exterior Finishes Available.
- Clear Acrylic Sealer - Exterior.
- Multiple K/O (Window and Door) Locations Available. (TBC)
- Optional Interior Finishes Available.
- Custom Heights Available.

General Notes:

- Product manufactured in accordance with CSA A23.4
- Lift Points Provided (See Shop Drawing for Quantity & Locations)
- Site Installation & Suitability for Use is the responsibility of others

5323QS Panel Building

Scale 1:50 mm

Chamber: 22,280 kgs / 49,100 lbs

Rev: 22Dec08

Dwg#: 5323QS-20-ZZZZ-C



A.E. CONCRETE
 Con-Force Division of Armtec Limited Partnership
Office: 19060 - 54th Ave. Surrey, BC V3S 8E5
 Tel (604) 576-1808 Fax (604) 576-2454
Shipping: 5353 - 192nd St. Surrey, BC V3S 8E5
 Website: www.ae-concrete.com

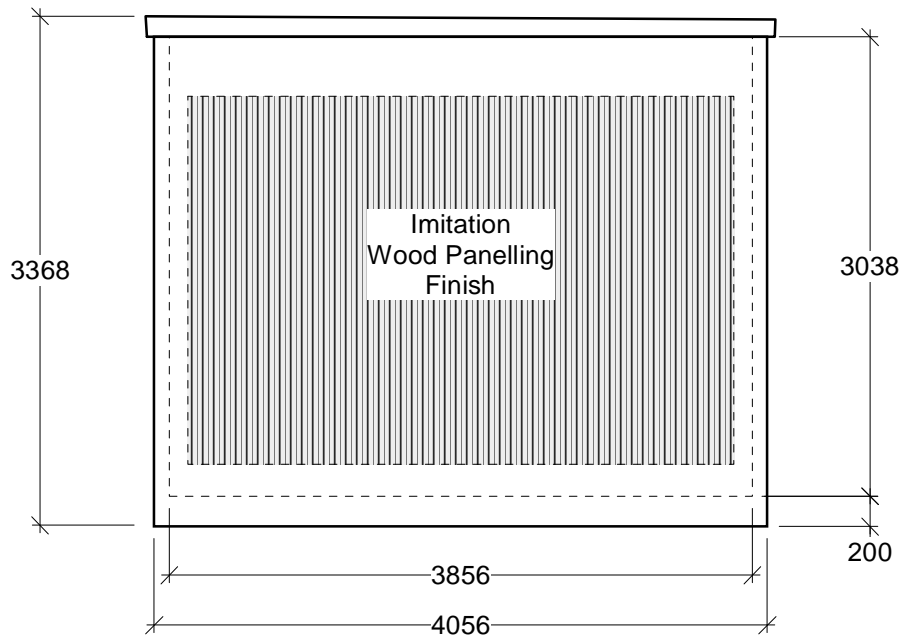

Front View

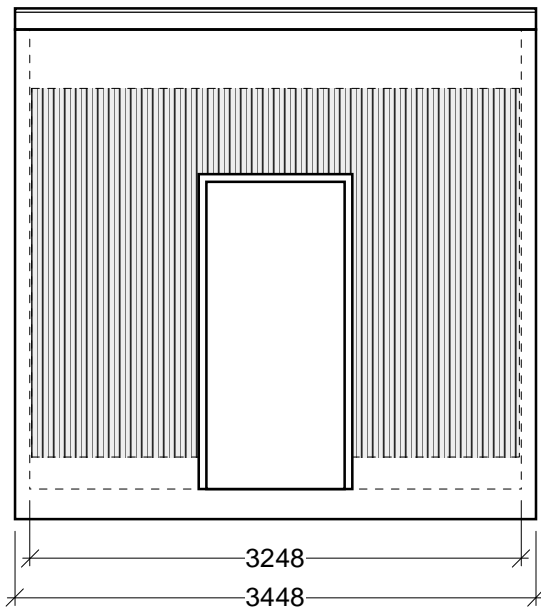

End View

- Roof Coverings and Eaves Trough Available.
- Standard Simulated Wood Finish or a Variety of Other Exterior Finishes Available.
- Clear Acrylic Sealer - Exterior.
- Multiple K/O (Window and Door) Locations Available. (TBC)
- Optional Interior Finishes Available.
- Custom Heights Available.

General Notes:

- Product manufactured in accordance with CSA A23.4
- Lift Points Provided (See Shop Drawing for Quantity & Locations)
- Site Installation & Suitability for Use is the responsibility of others

4323QS Panel Building

Scale 1:50 mm

Chamber: 45,340 lbs / 20,570 kgs



A.E. CONCRETE
 Con-Force Division of Armtec Limited Partnership
Office: 19060 - 54th Ave. Surrey, BC V3S 8E5
 Tel (604) 576-1808 Fax (604) 576-2454
Shipping: 5353 - 192nd St. Surrey, BC V3S 8E5
 Website: www.ae-concrete.com

Rev: 22Dec08

Dwg#: 4323QS-20-ZZZZ-C